



Assembly Instruction for Fiber Optic Series  
FOH  
Fischer Connectors



## Table des matières

1	Introduction .....	3
2	Document history .....	3
3	Definitions and Acronyms .....	3
4	FOH Plugs & Receptacles with Potting Set.....	4
5	FOH R01, R03 & R13 Receptacles with Wire Set.....	9
6	Terminus assembly .....	12
7	Polishing .....	14
8	Appendix .....	22

## 1 Introduction

This document covers :

- The application of Fischer FiberOptic Series electrical contacts and optical termini to electrical and fiber optic cables (singlemode and multimode fibers)
- The assembly of fiber optic cable with a cladding size of 125 µm and having the cable structure described in Fischer FiberOptic Series Cable Specifications
- The assembly of Fischer FiberOptic Series electrical contacts and optical termini and Rear Accessory sets (Wire, Cable Clamp and Potting sets) to Fischer FiberOptic Series Hybrid (referred as FOH in the present document)

Please read these instructions thoroughly before starting assembly.

## 2 Document history

Date	Revision #	Author	Controller	Modification description
15.03.2017	6.0	JGY	SRH/CMI	New Document
06.04.2017	7.0	JGY	SRH/CMI	Adding instruction for electrical contact assembly §6

## 3 Definitions and Acronyms

Text	Definition / Acronym
FO	Fischer FiberOptic
FO H	Fischer FiberOptic Series Hybrid
IEC	International Electrotechnical Commission

## 4 FOH Plugs & Receptacles with Potting Set

### Assembly steps

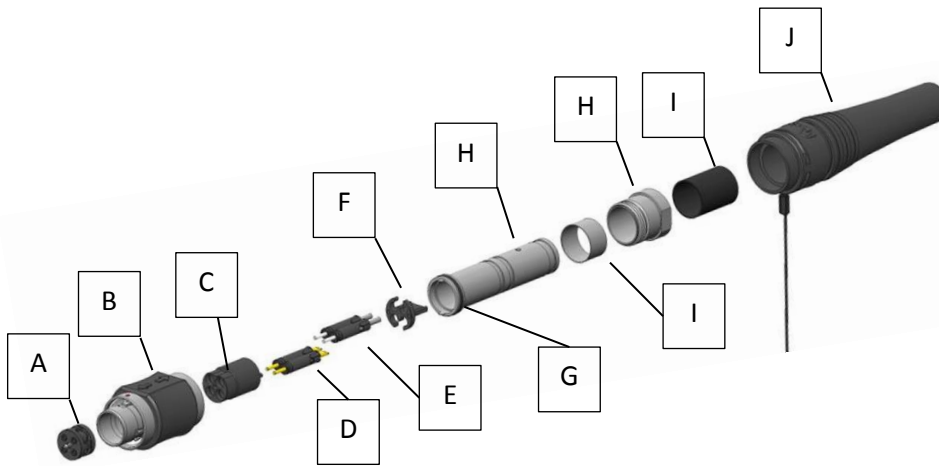

### Components list :

- A – Sleeve Holder
- B – Connector Body
- C – Insulator
- D – Optical termini
- E – Electrical termini
- F – Support Washer
- G – O-ring Seal
- H – Potting Set Body
- I – Crimping Sleeve
- J – Rear Nut
- K – Shrink Tube
- L – Bend Relief

Note : the pictures shown in this section represent a P01 Plug.

The following assembly steps are valid for P01 plug, as well as R01, R03, R13 and R50 receptacles, except the final step (sleeve holder assembly).

### Assembly steps

Picture	Process	Tools
	<p>Slide over the cable :</p> <ul style="list-style-type: none"> <li>- the Bend Relief "L"</li> <li>- the Shrink Tube "K"</li> <li>- Crimping sleeve "I"</li> <li>- the Rear Nut "J"</li> <li>- the Potting Set Body "P"</li> <li>- the O-Ring Seal "G"</li> </ul>	
<p>A: 70 [mm]                  B: 7 [mm]                  C: 54 [mm]                  D: 0 [mm]                  E: 42 [mm]                  F: 5 [mm]</p>	<p>Strip the cable to the dimensions as given on the picture.</p>	<p>Ruler, aramid shears, jacket stripper, and strip tool</p>
<p><b>Terminus assembly : see section 6</b>  <b>Polishing: see section 7</b></p>		

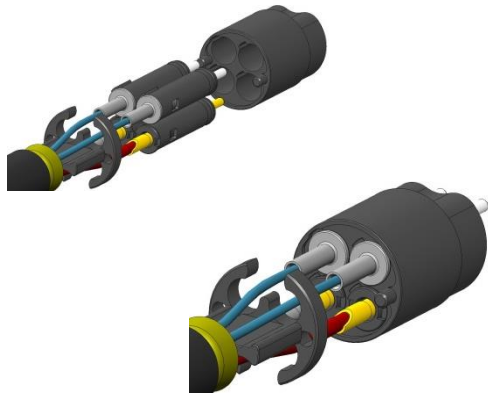

Insert all the termini "D" & "E" into the insulator "C".

When you insert the terminus "D", be careful to turn it during the insertion to not "bend" the contact O-ring.

Receptacle

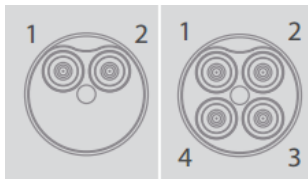

Plug

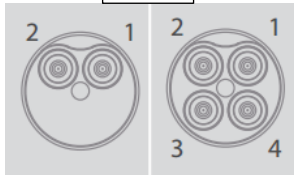

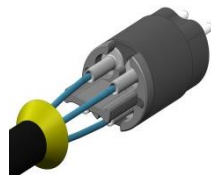

Pin Layout front view.

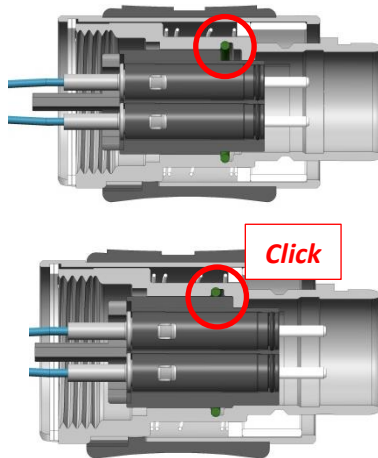

Place the Support Washer "F" around the termini "D" & "E".

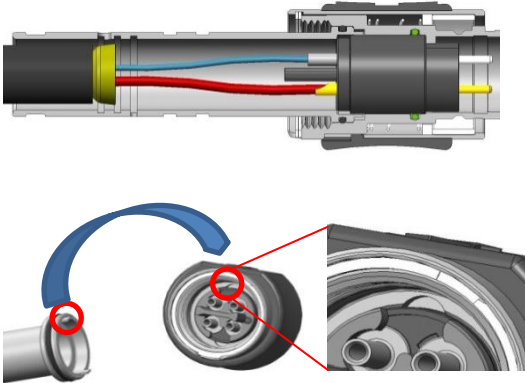
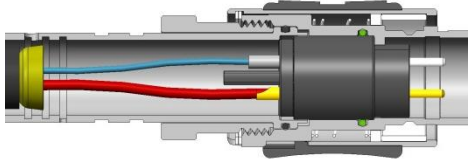

Push the contact bloc (termini "D" & "E" + insulator "C") with the Support Washer "F" until it clips.

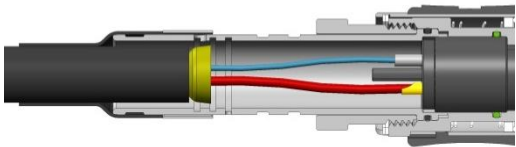
	<p>Position the O-Ring Seal "G" on the Potting Set Body "H" then slide the Potting Set Body "H" into the Connector Body "B".</p> <p>Be careful to the orientation of the back body.</p>	
	<p>Screw by hand the Rear Nut "J" on the Connector Body "B".</p>	
	<p>Screw the Rear Nut "J".</p> <p>Recommended torque : 5.0 Nm</p>	<p>Torque wrench [5Nm]  <b>Size 16</b>                  Counter piece: receptacle FO2/4</p>
	<p>Crimp the ground contact onto the Potting Set Body "H" using the crimping sleeve "I" .</p>	<p><b>Find tools drawing in appendixes.</b></p>
	<p>Slide the Shrink Tube "K" until the end of the shrink tube bottoms against the Potting Set Body "H" as shown on the left picture and heat it.</p>	<p>Heat gun</p> <p>Shrink tube operating temperature Range : -55°C to 110°C..</p>

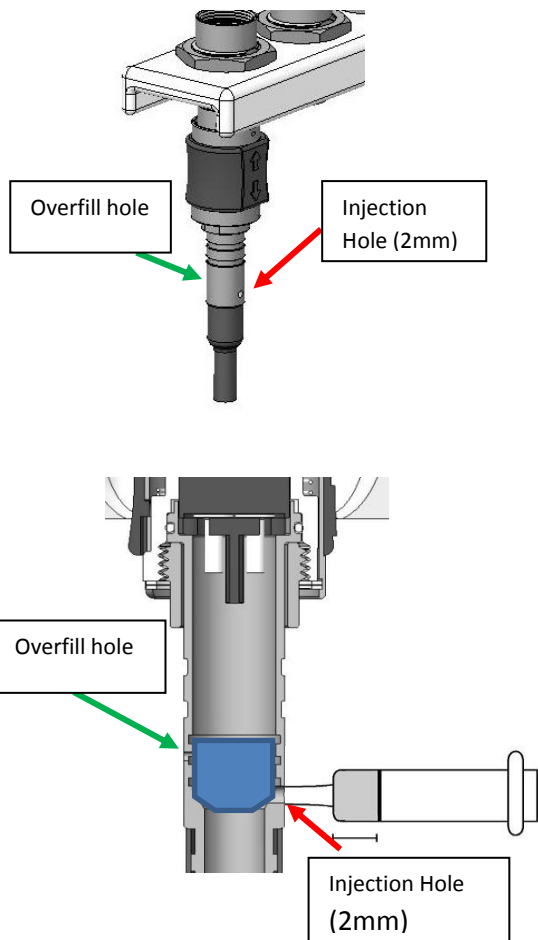

Slowly inject the epoxy inside the Potting Set Body "G" using the filling hole located at the bottom of the Potting Set Body "G".

Note : the second hole, smaller and located above the filling hole, is an overfilling hole. Stop injecting epoxy when epoxy starts to flow from this overfilling hole.

Resin Epoxy RS 851-044 Black

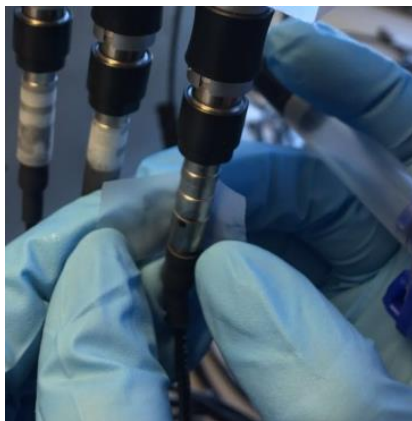

Remove any excess epoxy from the assembly (if any), apply tape on both filling and overfilling holes and place the assembly onto the curing oven block.

Curing time : 12 hours @ approx. 23°C.



Apply epoxy on the Shrink Tube "K" and slide the Bend Relief "L" until the end of the Bend Relief "L" bottoms against the Back Nut "J".

Epoxy: RT-355 Resintech



Insert Sleeve Holder "A" in the Connector Body "B".

Note : there is no sleeve holder for R01, R03,R13 and R50 receptacles. Thus, this final assembly step is valid only for P01 plug.





## 5 FOH R01, R03 & R13 Receptacles with Wire Set

### Assembly steps

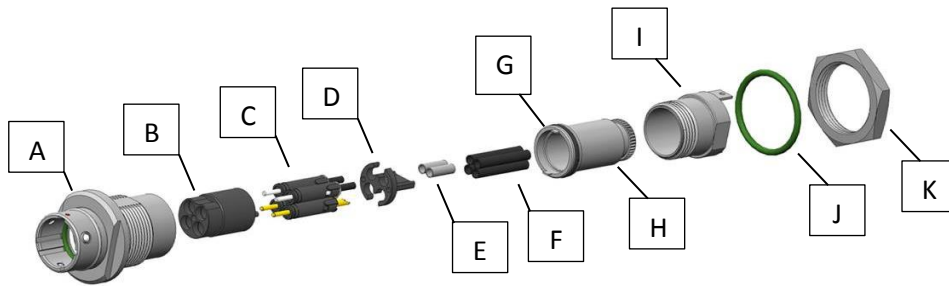

#### Components list :

- A – Connector Body
- B – Insulator
- C – Termini (Electric & optic)
- D – Support Washer
- E – Crimp Sleeve
- F – Shrink Tube
- G – O-ring
- H – Wire Set Body
- I – Wire Set Nut
- J – Connector Panel Seal
- K – Connector Nut



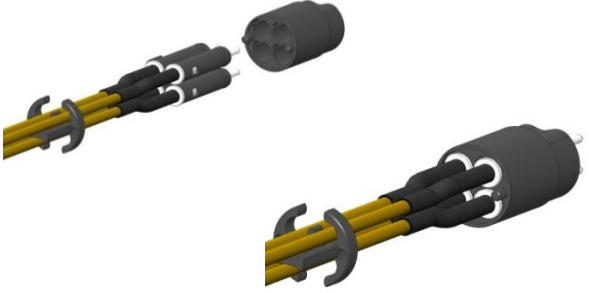
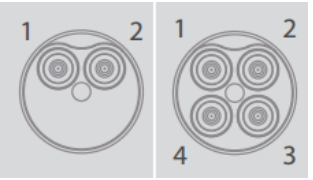
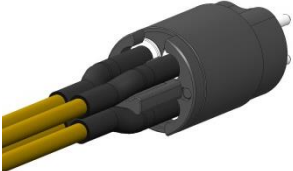
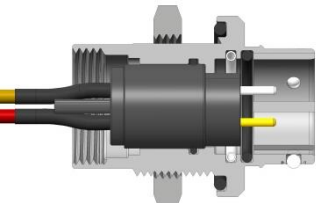
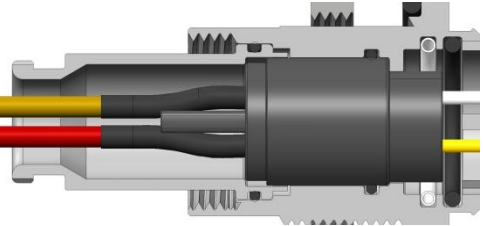

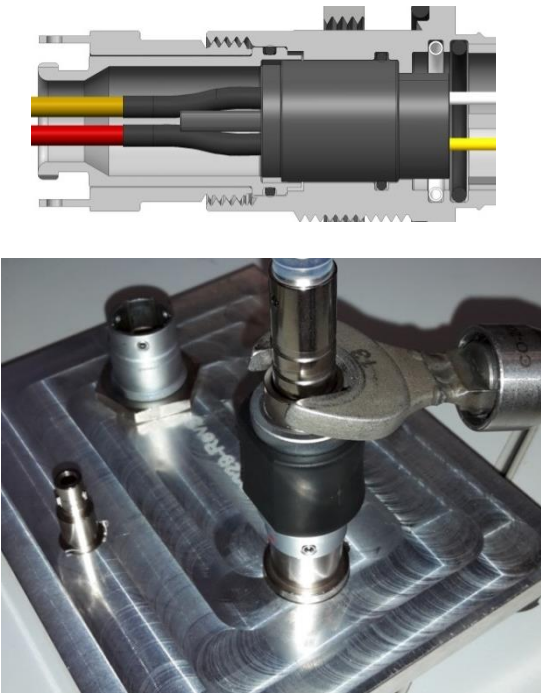
Picture	Process	Tools
	<p>Slide over the cable :</p> <ul style="list-style-type: none"> <li>- the Wire Set Nut "I"</li> <li>- the Wire Set Body "H"</li> <li>- The O-ring "G"</li> <li>- the Shrink Tube "F"</li> <li>- the Crimp Sleeve "E"</li> </ul>	
<p>Electric subcable jacket</p> <p>Copper</p> <p>Jacket</p> <p>Kevlar</p> <p>Buffer</p> <p>Fiber</p> <p>D : 0 [mm] E : 42 [mm] F : 5 [mm]</p> <p>A : 38 [mm] B : 8 [mm] C : 22 [mm]</p>	<p>Strip the cable to the dimensions as given on the picture.</p>	<p>Ruler, aramid shears, jacket stripper, and strip tool</p>
<b>Terminus assembly : see section 6</b>		
	<p>Uniformly distribute the cable strength members around the back of the Terminus "B".</p>	
	<p>Slide the Crimp Sleeve "E" over the cable strength members until the end of the crimp sleeve bottoms against the Terminus "B".</p>	<p>Find tools drawing in appendixes.</p>

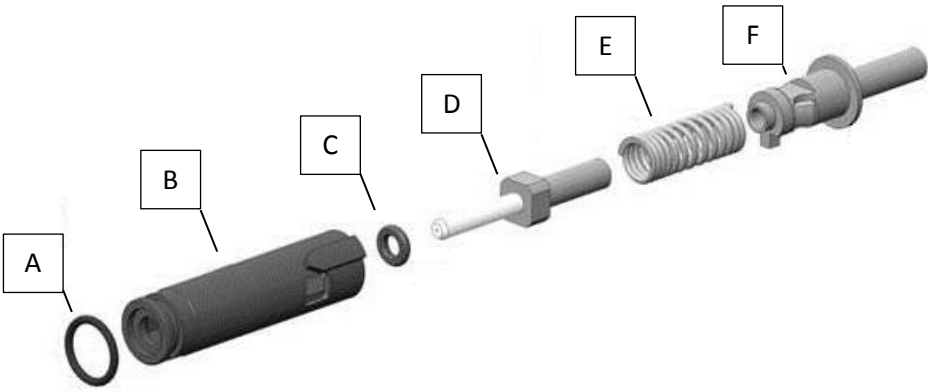

Picture	Process	Tools
	<p>Slide the Shrink Tube "F" over the Crimping Sleeve "E" and heat it.</p>	<p>Heat gun Shrink tube operating temperature Range : -55°C to 110°C.</p>
<b>Polishing: see section 7</b>		
	<p>Insert all the termini "C" into the insulator "B".</p> <p>When you insert the terminus "C", be careful to turn it during the insertion to not "bend" the contact O-ring.</p>	
<p style="text-align: center;">Receptacle</p> 	<p>Pin Layout front view.</p>	
	<p>Place the Support Washer "D" around the termini "C".</p>	
	<p>Push the contact bloc (termini "C" + insulator "B") with the Support Washer".</p>	
	<p>Insert the Wire Set Body "H" into the Connector Body "A".</p>	

Picture	Process	Tools
 <p>The technical drawing shows a cross-section of a connector body with a wire set nut being tightened onto a wire. The photograph shows a torque wrench being used to tighten a nut on a metal assembly.</p>	<p>Screw the Wire Set Nut "I" on the Connector Body "A".</p> <p>Recommended torque : 5.0 Nm</p>	<p>Torque wrench [5Nm] <b>Size 16</b></p>

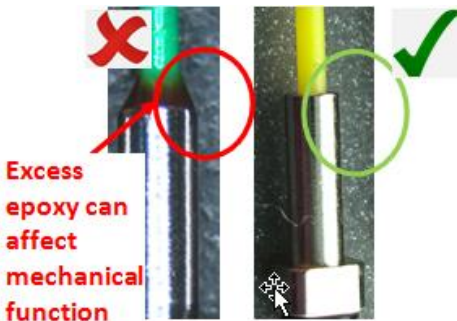
## 6 Terminus assembly

Assembly steps	
	<p>Components list :</p> <ul style="list-style-type: none"> <li>A – Housing O-Ring</li> <li>B – Termini Housing</li> <li>C – Ferrule O-Ring</li> <li>D – Ferrule</li> <li>E – Spring</li> <li>F – Termini Closure</li> </ul>

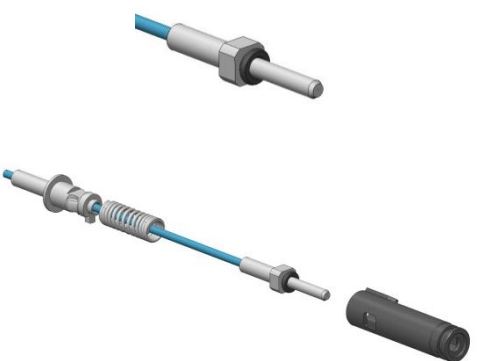
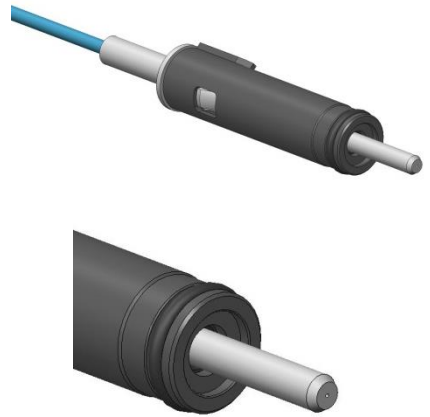

Picture	Process	Tools
	<p>Slide over the cable :</p> <ul style="list-style-type: none"> <li>- the Termini Closure "F"</li> <li>- the Spring "E"</li> </ul>	
<b>Prepare the cable according to stripping dimension from the relevant section.</b>		
	<p>Insert epoxy into the Ferrule "D" until a little drop appears at the ferrule end.</p> <p>Carefully insert the fiber into the back of the Ferrule "D and make sure the buffer slides inside the ferrule the buffer bottoms on the ceramic.</p>	<p>Extended Working Life, 2-Part Epoxy, 2.5 Gram Packet Frs : FIBER OPTIC CENTER Ref : ET383ND-2.5G</p>
 <p>Excess epoxy can affect mechanical function</p>	<p>Remove any excess epoxy from the assembly</p>	
	<p>Cure the epoxy</p>	<p>120 +10/- 20[°C] during 20min.</p>
	<p>Cleave fiber</p>	<p>Scribe Tool</p>



	<p>Position the Ferrule O-ring "C" on the Ferrule "D" as shown on the top left picture.</p> <p>Slide the Spring "E" and Termini Closure "F" at the back of the Ferrule "D" and assemble them into the Termini Housing "B".</p>	
	<p>Position the Housing O-ring "A" on the Termini Housing "B" as shown on the left picture.</p>	
<b>Solder contact</b>		
	<p>Solder the wire to the contact</p>	

## 7 Polishing

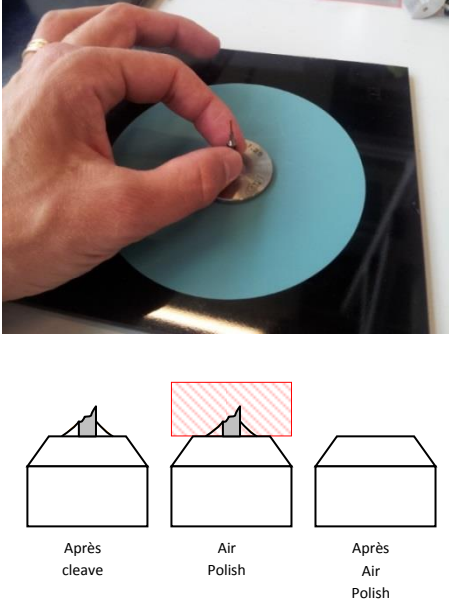
It is recommended polishing the fiber using a polishing machine.

Polish the fiber according to the machine manufacturer's instructions.

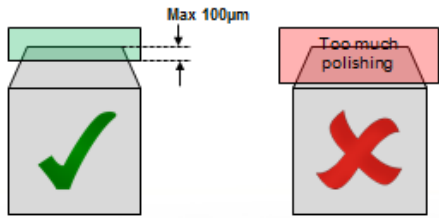
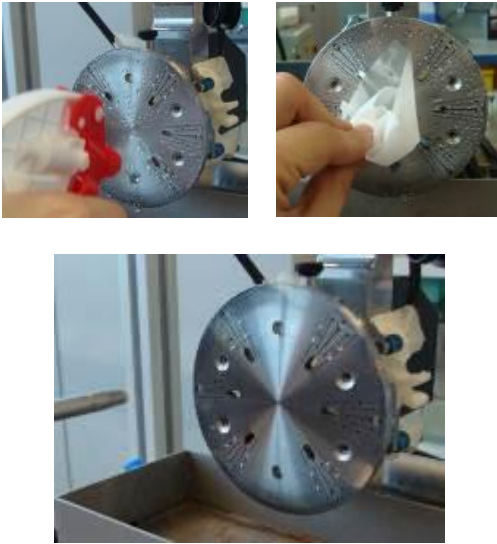
Picture	Process	Tools
<b>PC termini</b>		
	<p><b>Step1 : Air polish</b></p> <p>Holding the polishing bushing and terminus, place the polishing bushing on the film. Using light pressure on the ferrule, polish the endface of the ferrule in a small circular motion.</p>	<ul style="list-style-type: none"> <li>▪ Polishing film: 9µm Silicon carbide</li> <li>▪ Polishing Pad : N/A</li> <li>▪ Lubricant: N/A</li> <li>▪ Tool: FO-10090</li> </ul>
	<p>Clean the polishing pad with demineralized water and lint-free cloth, from the center outwards.</p> <p>Spray some demineralized water on the polishing pad and place the polishing film, starting at edges of the polishing pad.</p> <p>Spray abundantly demineralized water on the polishing film.</p>	

	<p><b>Step 2 :</b></p> <p>Polish the termini with 5µm Silicon carbide polishing film, until no peripheral chips are visible.</p> <p><b>Do not remove more than 100 µm.</b></p>	<ul style="list-style-type: none"> <li>▪ Polishing film: 5µm Silicon carbide</li> <li>▪ Polishing Pad : 90 duro black</li> <li>▪ Lubricant: DI-water</li> <li>▪ Fixture tool: FO-10019</li> </ul>
	<p>Wipe abundantly the polishing tool holding the termini with demineralized water and clean it carefully with a lint-free cloth.</p> <p>Use an airpressure gun to remove residual water.</p>	
	<p>Clean the polishing pad with demineralized water and lint-free cloth, from the center outwards.</p> <p>Spray some demineralized water on the polishing pad and place the polishing film, starting at edges of the polishing pad.</p> <p>Spray abundantly demineralized water on the polishing film.</p>	
	<p><b>Step 3 :</b></p> <p>Polish the termini with 1µm Diamond polishing film in an 8 pattern motion (or pattern of the polishing machine).</p>	<ul style="list-style-type: none"> <li>▪ Polishing film: 1µm Diamond</li> <li>▪ Polishing Pad: 80 duro green</li> <li>▪ Lubricant: DI-water</li> <li>▪ Fixture tool: FO-10019</li> </ul>

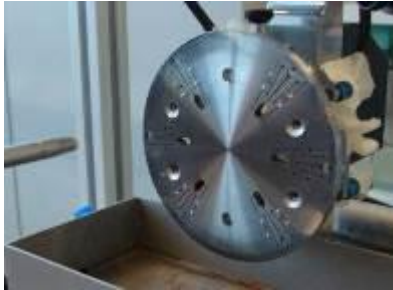
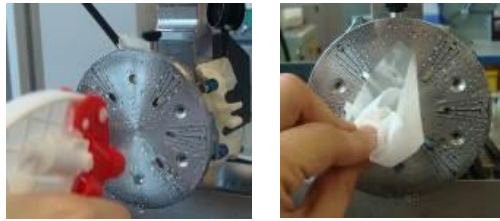

Wipe abundantly the polishing tool holding the termini with demineralized water and clean it carefully with a lint-free cloth.

Use an airpressure gun to remove residual water.



Clean the polishing pad with demineralized water and lint-free cloth, from the center outwards.

Spray some demineralized water on the polishing pad and place the polishing film, starting at edges of the polishing pad.

Spray abundantly demineralized water on the polishing film.

**Step 4 :**

Polish the termini with AngstromLap Final Polish SiO<sub>2</sub> in an 8 pattern motion.

**Do not clean the polishing tool after this step, to avoid creating scratches on the polished ferrule.**

- Polishing film: AngstromLap Final Polish SiO<sub>2</sub>
- Polishing Pad: 80 duro green
- Lubricant: DI-water
- Fixture tool: FO-10019



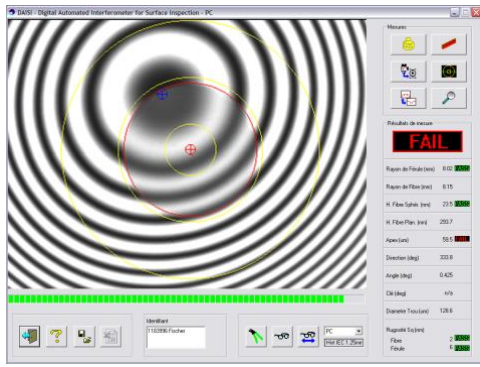

**Geometrical control :**

**Ferrule Radius[mm]:**  
Min 5 - Max 12

**Apex Offset[um]:**  
Min 0.0 – Max 50.0

If fail, repeat from step 3.

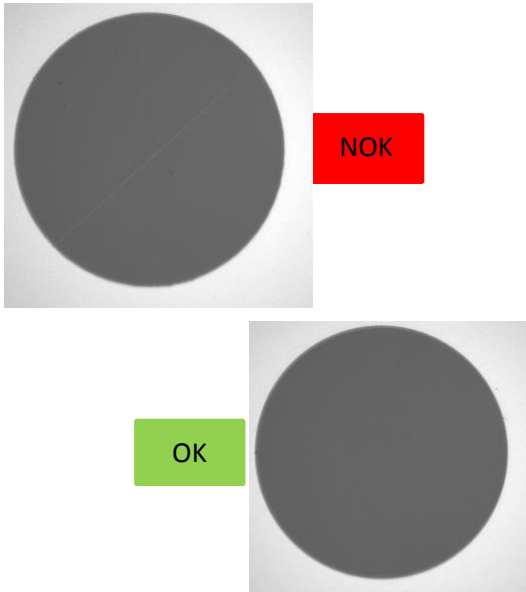

**Fiber core inspection :**

Examine the endface of the ferrule for scratches according to left pictures.

If fail, repeat from step 4.



If not installing the connector immediately, install a protective cover onto terminus to prevent contamination to the endface of the ferrule.

**8° APC termini**

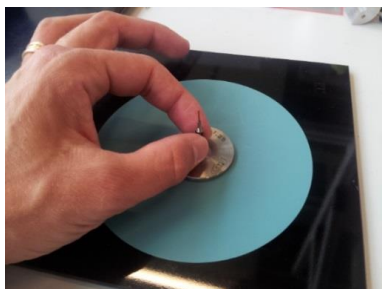







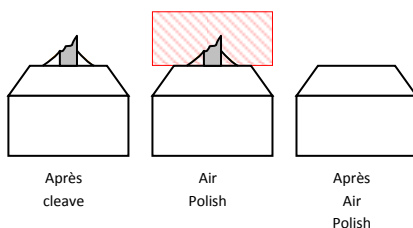

**Step1 : Air polish**

Holding the polishing bushing and terminus, place the polishing bushing on the film.

Using light pressure on the ferrule, polish the endface of the ferrule in a small circular motion.

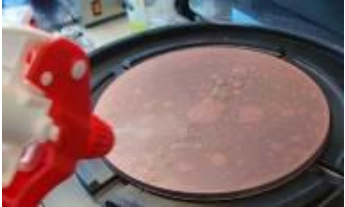
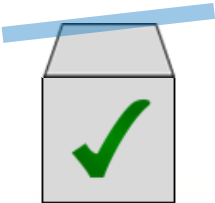
- Polishing film: 9µm Silicon carbide
- Polishing Pad : N/A
- Lubricant: N/A
- Tool: FO-10090

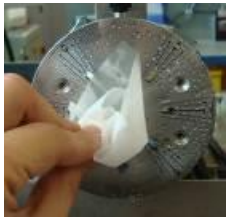

    	<p>Clean the polishing pad with demineralized water and lint-free cloth, from the center outwards.</p> <p>Spray some demineralized water on the polishing pad and place the polishing film, starting at edges of the polishing pad.</p> <p>Spray abundantly demineralized water on the polishing film.</p>	
   	<p><b>Step 2 :</b></p> <p>Polish the termini with 8° angle using the fixture tool.</p> <p>Make sure the endface of the ferrule is fully polished, as shown on the left pictures.</p> <p>If not, repeat from step 2.</p>	<ul style="list-style-type: none"> <li>▪ Polishing film: 5µm Diamond</li> <li>▪ Polishing Pad: Glass</li> <li>▪ Lubricant: DI-water</li> <li>▪ Fixture tool: TX00.285</li> </ul>
 	<p>Wipe abundantly the polishing tool holding the termini with demineralized water and clean it carefully with a lint-free cloth.</p> <p>Use an airpressure gun to remove residual water.</p>	

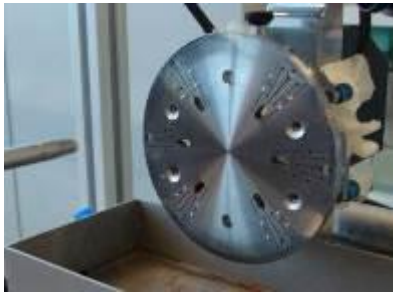

Clean the polishing pad with demineralized water and lint-free cloth, from the center outwards.

Spray some demineralized water on the polishing pad and place the polishing film, starting at edges of the polishing pad.

Spray abundantly demineralized water on the polishing film.

**Step 3 :**

Polish the termini with 1µm Diamond polishing film in an 8 pattern motion (or pattern of the polishing machine).

- Polishing film: 1µm Diamond
- Polishing Pad: 80 duro green
- Lubricant: DI-water
- Fixture tool: TX00.285

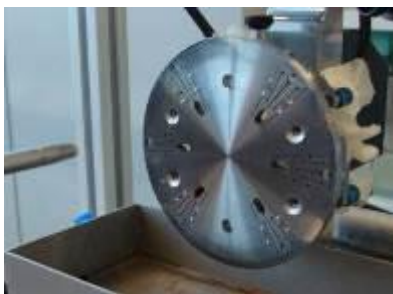
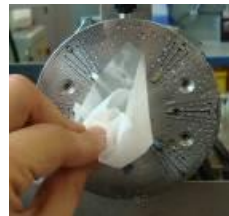
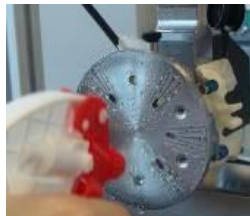

Wipe abundantly the polishing tool holding the termini with demineralized water and clean it carefully with a lint-free cloth.

Use an airpressure gun to remove residual water.

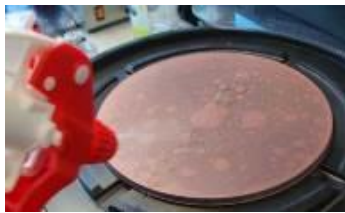

Clean the polishing pad with demineralized water and lint-free cloth, from the center outwards.

Spray some demineralized water on the polishing pad and place the polishing film, starting at edges of the polishing pad.

Spray abundantly demineralized water on the polishing film.

**Step 4 :**

Polish the termini with AngstromLap Final Polish SiO<sub>2</sub> in an 8 pattern motion.

**Do not clean the polishing tool after this step, to avoid creating scratches on the polished ferrule.**

- Polishing film: AngstromLap Final Polish
- Polishing Pad:80 duro green
- Lubricant: DI-water
- Fixture tool: TX00.285

**Geometrical control :**

**Ferrule Radius[mm]:**

Min 5 - Max 12

**Apex Offset[um]:**

Min 0.0 – Max 50.0

If fail, repeat from step 3.

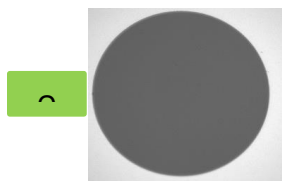
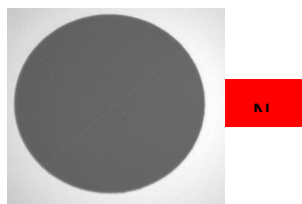
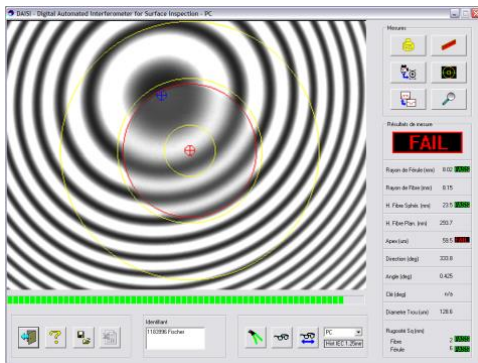

**Fiber core inspection :**

Examine the endface of the ferrule for scratches according to left pictures.

If fail, repeat from step 4.



If not installing the connector immediately, install a protective cover onto terminus to prevent contamination to the endface of the ferrule.

## 8 Appendix

### Tool drawing for crimping the sleeve to the contact

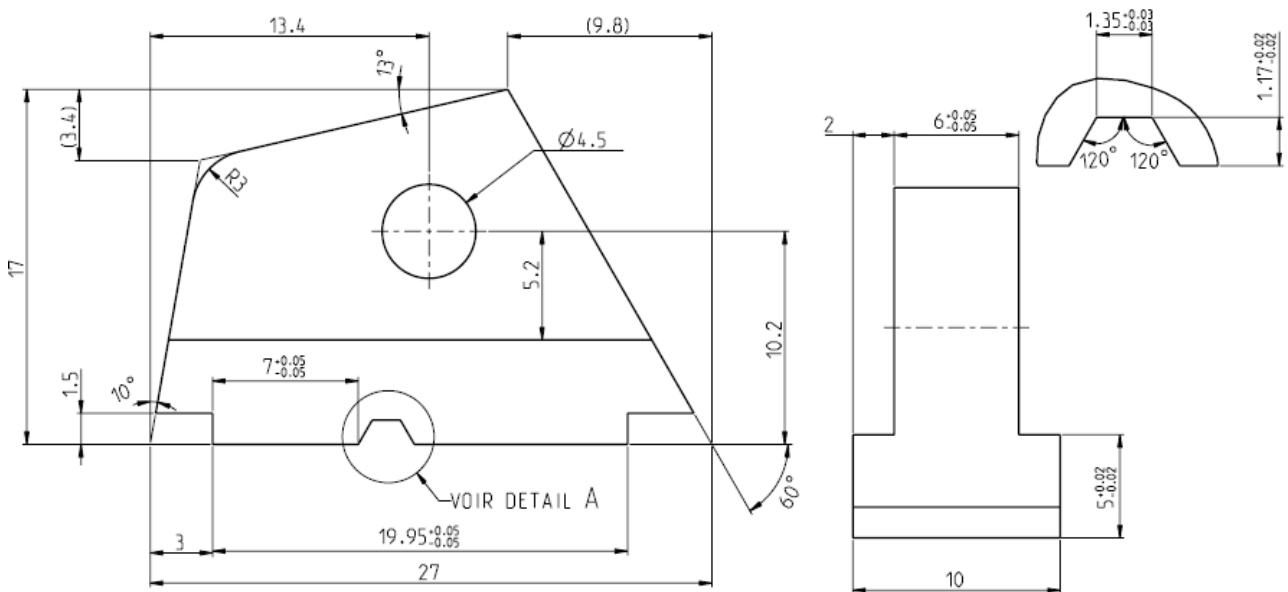
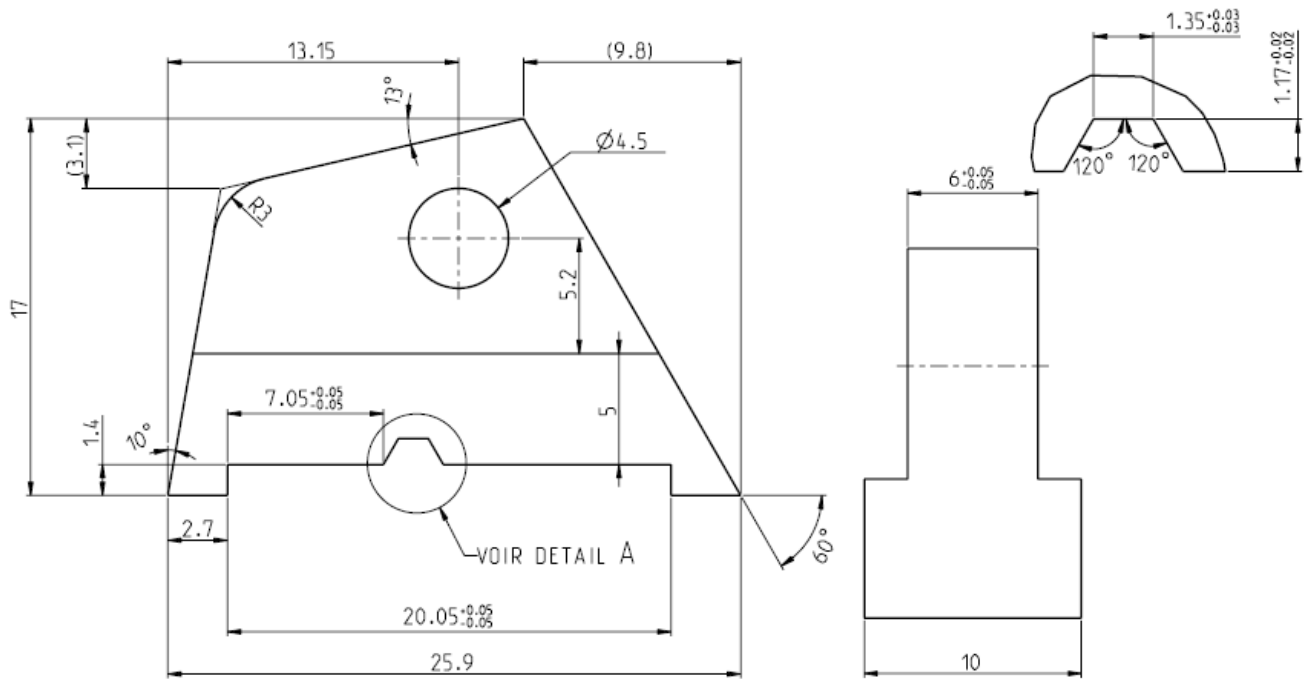

**Tool drawing for crimping the ground contact to the rear body (FOH)**

